



SUMITOMO CHEMICAL

Aluminium Dept.

Inorganic Materials Div.

Super High Purity Aluminium



Title

Shape of products	page 3
Manufacturing method of Super High Purity Aluminium	page 4
Example of specifications (chemical composition)	page 5
Features of Ultra High Purity Aluminium	page 6
Corrosion properties	page 7
Strength properties	page 8
Conduction properties (Cryogenic temperature)	page 9
Conduction properties (Room temperature)	page 10

<Notice>

(1) The listed values are representative values and are not guaranteed values.

Please also note that listed products may be changed or discontinued without prior notice for improvement purposes.

(2) The applications shown are examples of use. The final decision on use is at the customer's own discretion.

(3) Please refrain from using products for medical purposes or for applications which contact with food.

Shape of products

We supply slabs, billets, ingots, plates, wires and cut wire shape.

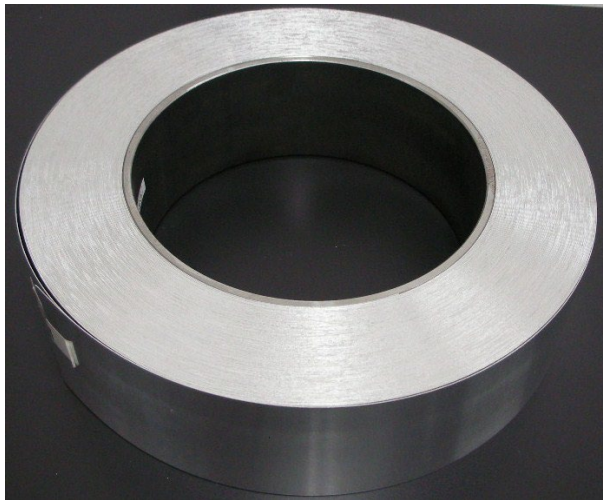

Manufacturing method of Super High Purity Aluminium

Sumitomo Chemical manufactures Super High Purity Aluminium by two methods, three-layer electrolytic and segregation methods.

Three-layer electrolytic method

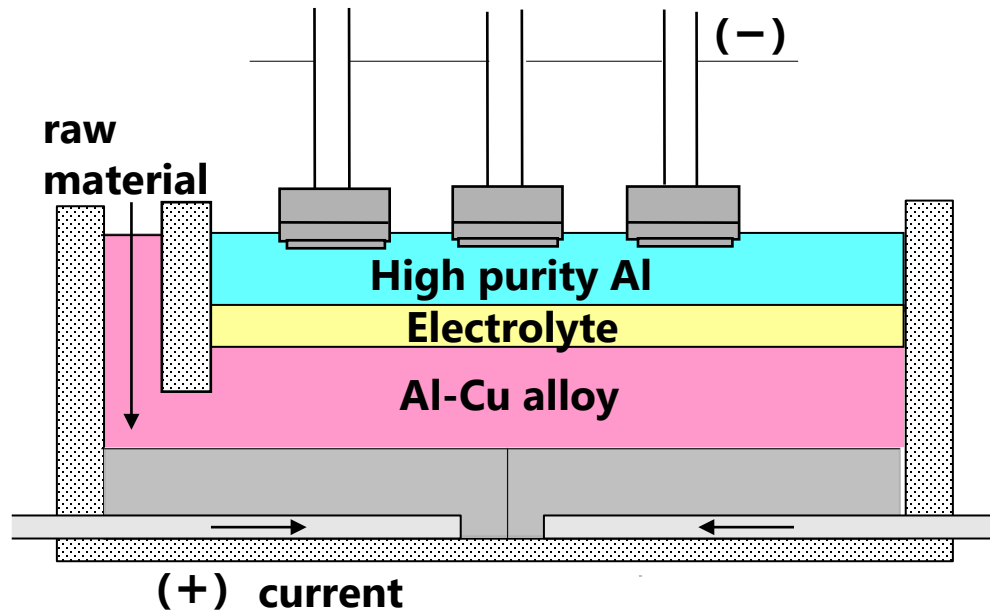

Segregation method

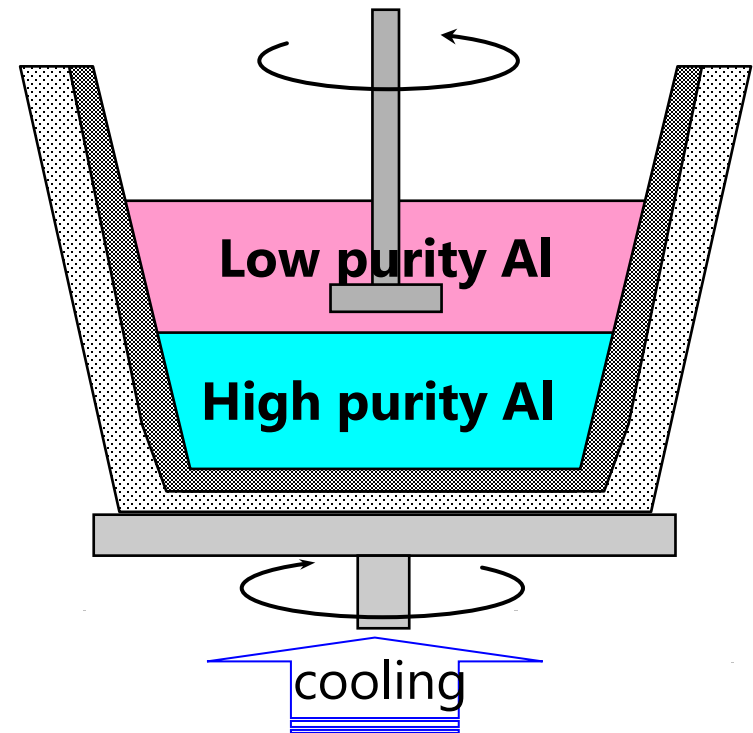

Please see the link below for further information.

[Sumitomo Chemical 2013](#)

['Refining Technology and Low Temperature Properties for High Purity Aluminium'](#)

Example of specifications (chemical composition)

We are able to adjust the purity and chemical composition according to your request.

Unit: wt.ppm

	Al	Si	Fe	Cu	Mn	Mg	Zn	Ti	Ga	V	U, Th
4N	≥99.99%	≤30	≤20	≤20	≤10	≤10	≤20	≤5	≤20	≤5	–
5N	≥99.999%	≤3	≤3	≤3	≤1	≤3	≤1	≤1	≤1	≤1	–
6N	≥99.9999%	≤0.6	≤0.2	≤0.2	≤0.2	≤0.2	≤0.2	≤0.2	≤0.2	≤0.2	≤0.001

Features of Ultra High Purity Aluminium (5N or more)

- **Excellent anti-corrosive properties**
- **Soft and Easy for machining**
- **High electrical and thermal conductivities**
- **Lightweight**
- **High reflectance**

Excellent anti-corrosive properties

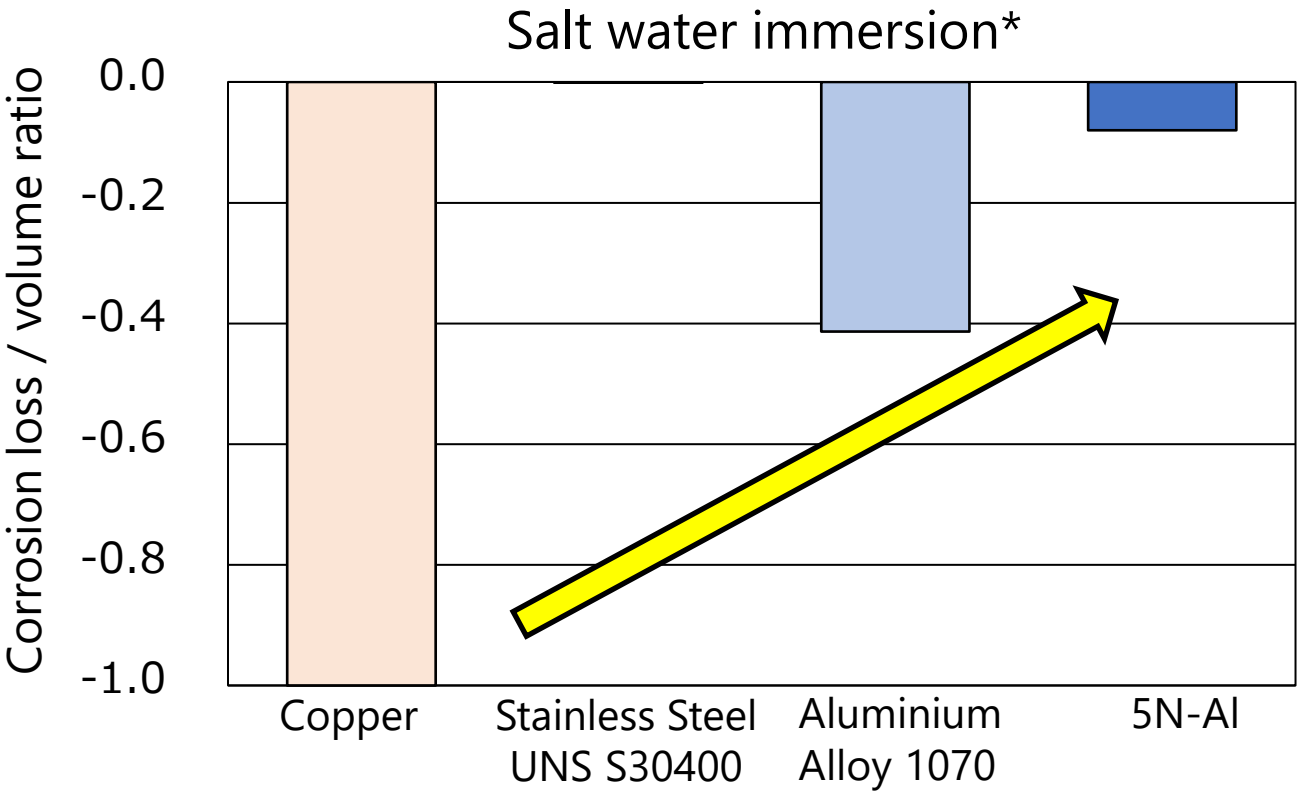

*3.5%NaCl aq., set to pH=3 using acetic acid, soaked for 72hr

Soft and Easy for machining

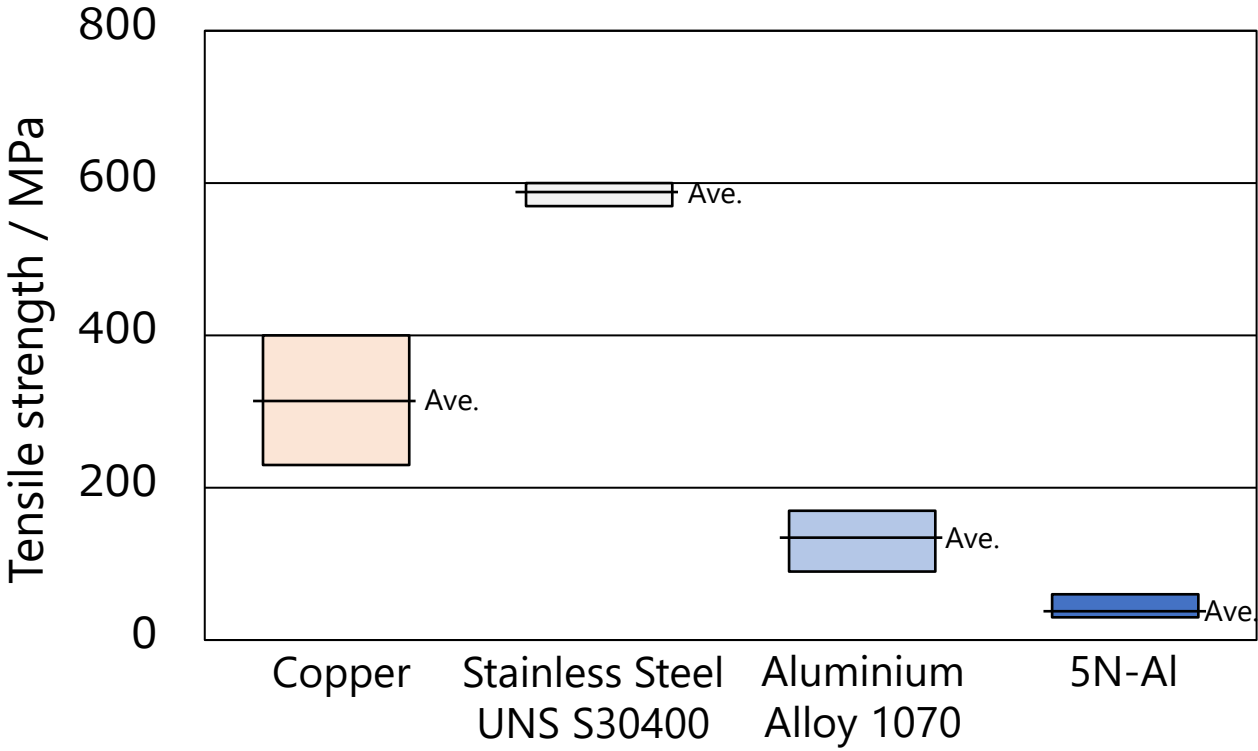

Conduction properties (Cryogenic temperature)

High electrical and thermal conductivities under cryogenic temperature

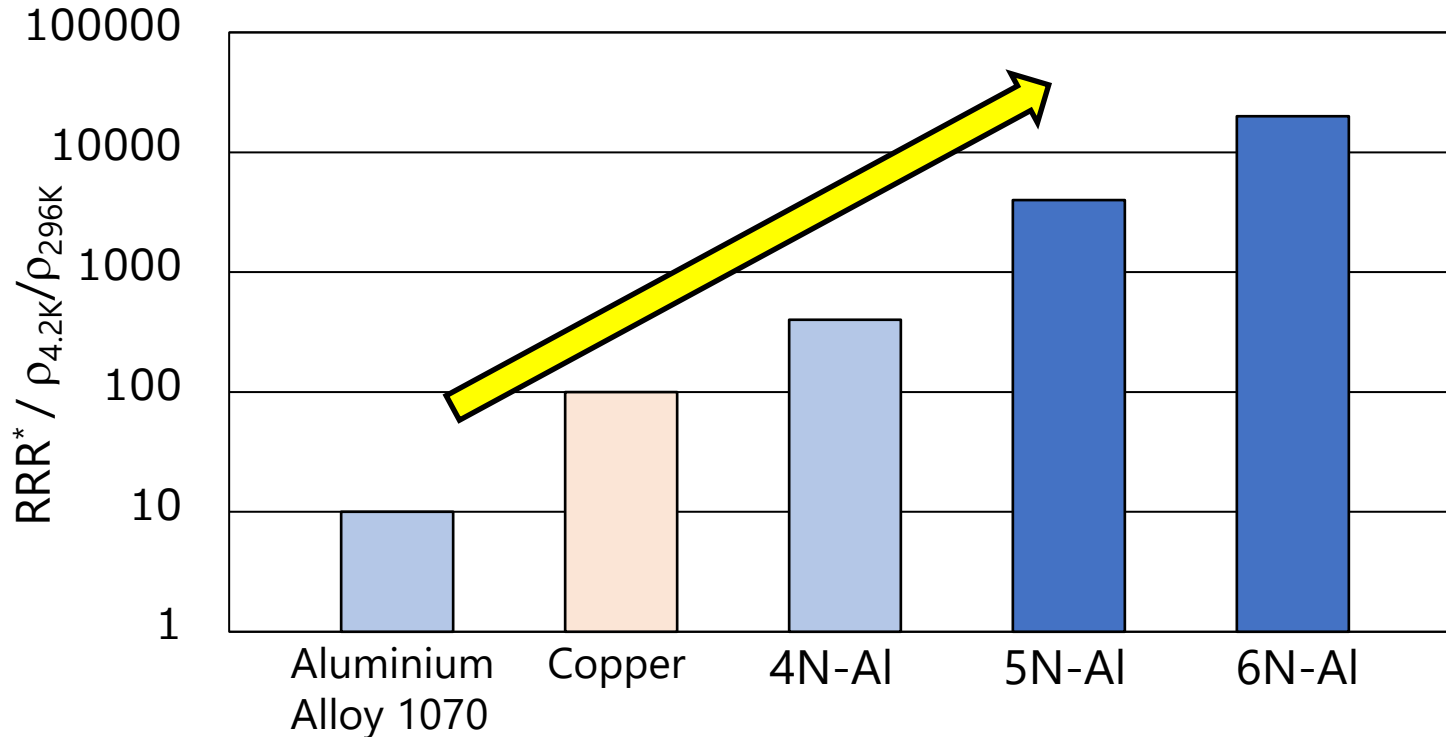

* RRR (Residual Resistivity Ratio)

The ratio of electrical resistivity of under room temperature (296K) and under boiling point of liquid helium (4.2K)

Please see the link below for further information.

[Sumitomo Chemical 2013](#)

['Refining Technology and Low Temperature Properties for High Purity Aluminium'](#)

Conduction properties (Room temperature)

Replacing with aluminium to reduce weight

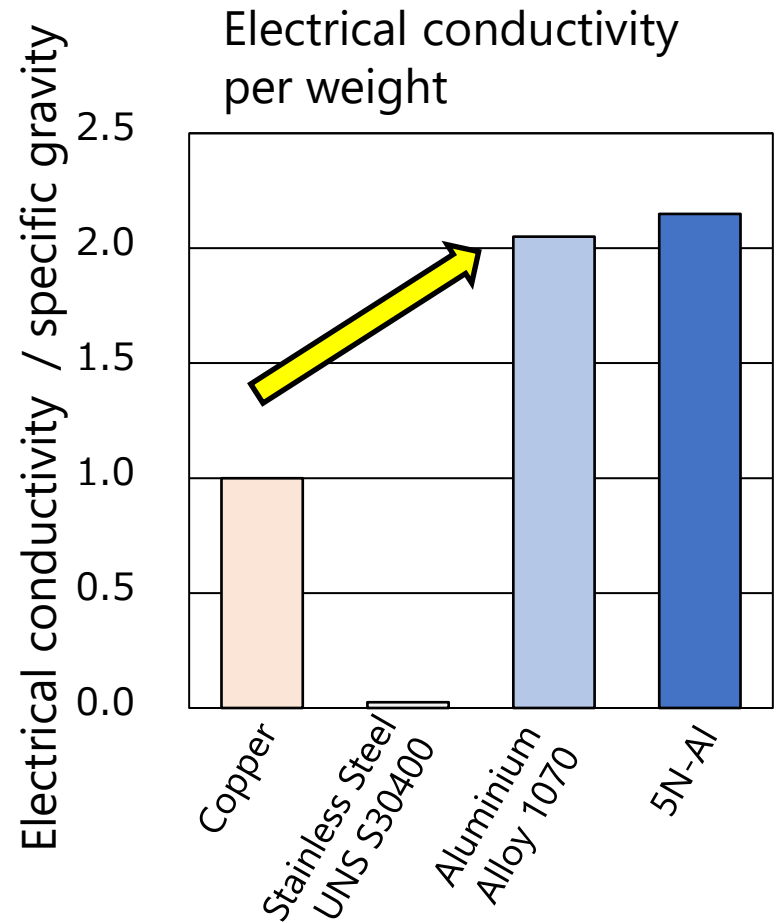
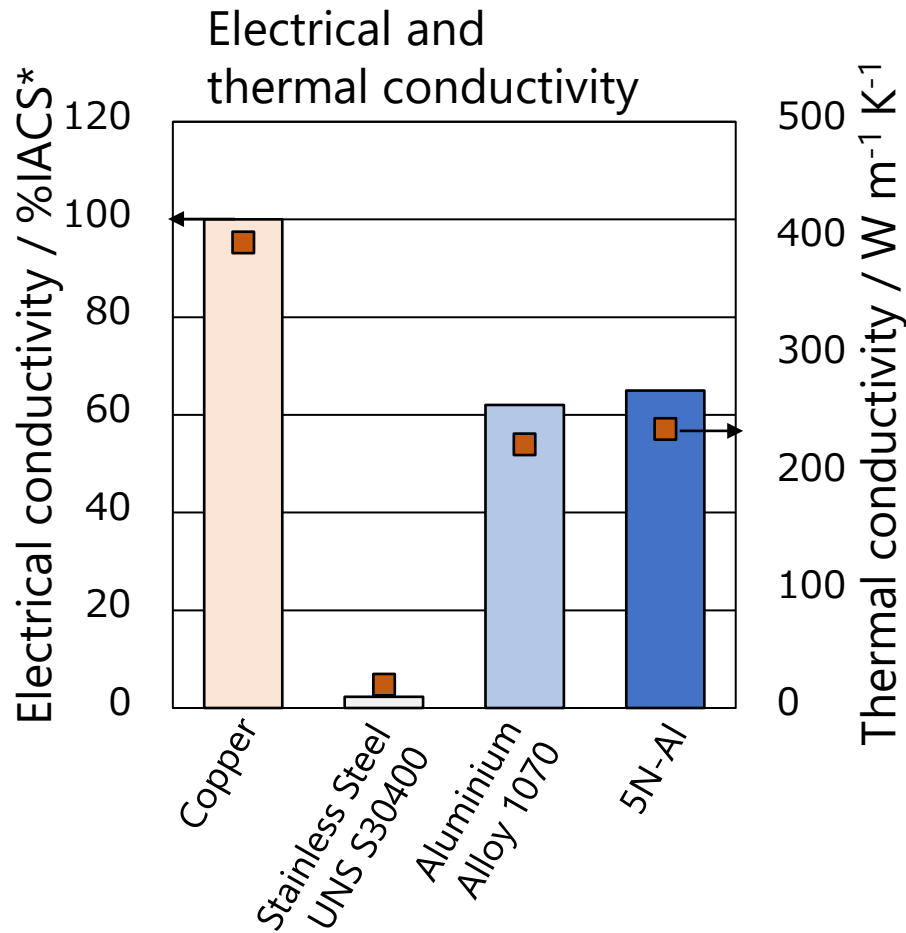

* %IACS Conductivity when international standard annealed copper conductivity is set as 100



Sumitomo Chemical Co., Ltd.

Aluminium Dept.

Inorganic Materials Div.

2-7-1, Nihonbashi, Chuo-ku, Tokyo, 103-6020, JAPAN

TEL: +81-3-5201-0261

URL: [Inquiries about our Products | SUMITOMO CHEMICAL \(sumitomo-chem.co.jp\)](https://www.sumitomo-chem.co.jp)